

# Putzmeister

56Z-METER | TRUCK-MOUNTED CONCRETE BOOM PUMP

56Z-METER



# A NEW STANDARD OF INNOVATION AND EXCELLENCE

## DO MORE FOR LESS

With the 56Z-Meter, Putzmeister makes it possible to get the reach of the 50-meter class in a boom pump with a smaller footprint.

Weighing in at 100,000 pounds, the 56Z-Meter is light and compact enough to maneuver and pump in spaces where other 50-meter class booms simply cannot fit. Its two-section outriggers featuring our One-Sided Support (OSS) system help make deployment in confined spaces possible. Combine that with a 180' 10" vertical reach, and the maneuverability of the 56Z-Meter is tough to beat.

The flexibility of the boom's five-section Z-Fold design further enhances both placement options and the all-around convenience of this 50-meter class model. For maximum versatility, the boom's sections can be deployed in either the 'Z' position or the 'A-Frame' configuration, depending on the application requirements.

Designed and built with customary Putzmeister flexibility, strength, and dependability, the 56Z-Meter brings together world-class design and user value in a package that is both site-friendly and fully compliant with DOT weight restrictions.



3

### AMPLE STORAGE SPACE

With two spacious decks, there is plenty of room to comfortably move around the deck and ample capacity for storage of pipe, hose and job site equipment.



4

### IMPROVED PIPE LAYOUT

Improved pipe layout, with single bend in turret and only two elbow sizes – 45-degree and 90-degree – increases parts commonality and reduces wear.



5

### CONVENIENT OUTRIGGERS

Two-section outriggers and One-Sided Support (OSS) allow the 56Z to safely maneuver in tight spaces. In addition, four identical bolt-on outrigger slewing cylinders make simple work of maintenance.

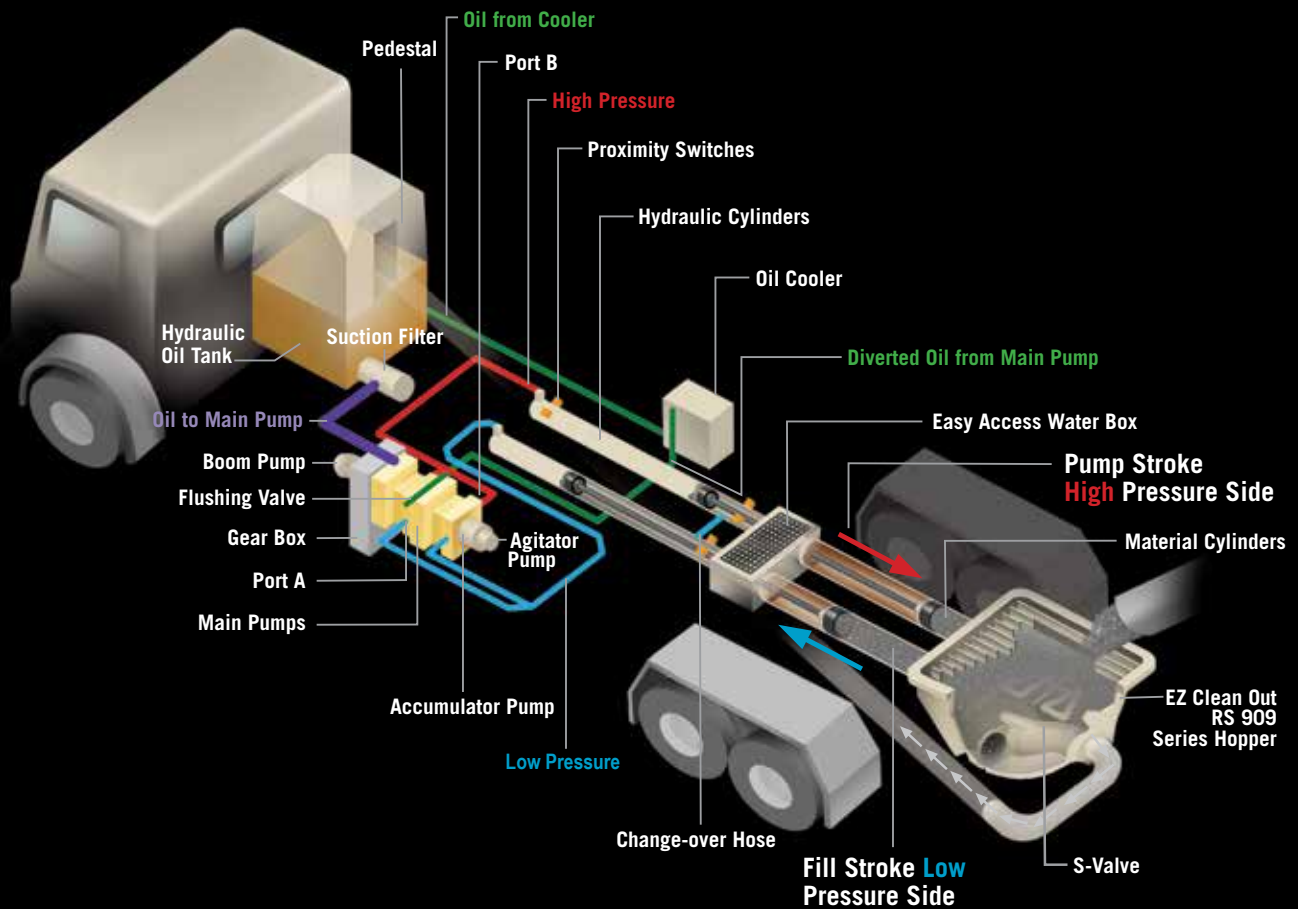

## PUTZMEISTER | FREE FLOW HYDRAULICS

### FREE FLOW HYDRAULICS IN A CLOSED LOOP SYSTEM

The pumps at the heart of Putzmeister's free flow pumping system are bi-directional, variable displacement piston pumps. Depending on stroke, oil flows in a closed loop from either port A or port B on the pump to the hydraulic cylinders.

Depending on the specific pump cell size, up to 20% of the oil leaves the simple closed loop system during each stroke through a flushing valve on the main pump and cycles to a cooler before it returns to the hydraulic oil tank. Removing and cooling only this minimal amount of oil is possible because, unlike an open loop system, the oil flows freely without passing through any unnecessary valves that can generate heat.

The closed loop also requires far less oil to run the system, as a larger reservoir is not necessary to cool all of the oil.

Speed and timing are also critical to superior performance. Quicker and more responsive than a hydraulic signal, the electrical system on a Putzmeister pump minimizes the time it takes to change direction at stroke end.

An electrical signal precisely synchronizes the drive cylinders with the accumulator system that controls the S-Valve in the hopper. Reserved energy stored in a nitrogen bladder is sent as a supercharged blast of oil at precisely the right moment to facilitate a smooth and fast shift of the S-Valve from one position to another.

### KEY ADVANTAGES OF PUTZMEISTER'S FREE FLOW HYDRAULICS

- Changes in material pressure in the delivery line are reduced to ensure smooth pumping and a consistent concrete flow.
- The intelligent design minimizes wear-inducing pressure peaks, increases service life and makes our pumps extremely powerful.
- Rapid change-over of the stroke means higher outputs, a smoother flow of concrete and less boom bounce.
- There is greater pump output due to the efficient use of all available energy.

# 56Z-METER | TRUCK-MOUNTED CONCRETE BOOM PUMP STANDARD FEATURES

## BOOM

---

- 180' 10" (55.12m) vertical reach
- Versatile 5-section Z-Fold boom
- Automatic lubrication
- Integrated work lights

## BOOM OPERATION AND CONTROL

---

- Fully proportional HBC radio remote
- Smooth and precise boom positioning at greater distances
- Fully proportional remote with 164' 0" (50m) cable
- Gauge Port Central (GPC)
- Modular Boom Controls (MBC)
- 24V electrical system

## DELIVERY LINE

---

- Equipped with 5" (125mm) twin-pipe delivery line on all boom sections providing efficient concrete delivery
- Easy lift-out brackets for simple delivery line replacement
- Standardized 45° and 90° elbows and straight pipe sections
- Improved pipe layout reduces pipe wear
- Common component availability and easy replacement

## PEDESTAL

---

- Rotation bearing and access openings simplify turret pipe changes
- Fully integrated pedestal design absorbs all forces
- Easy access large single-suction filter with indicator gauge
- Condensation trap in the hydraulic tank for water collection
- Increased deck space and payload capacity for pipe and hose storage
- Automatic lubrication
- Side-mounted aluminum toolboxes
- Integrated work lights
- Breakaway rear steps

## OUTRIGGERS

---

- Two-part outriggers for easy maintenance
- Quick setup on restrictive job sites
- Fully hydraulic outriggers with integral cylinders
- "X" brace outrigger system
- Front outriggers extend diagonally out and down
- Rear outriggers swing out and extend down
- Four outrigger pads in two side compartments
- Bubble level indicators
- Fuel tank in outrigger – 212 gallon (803L)
- One-Sided Support (OSS) system featuring a 120° working range

## CONCRETE PUMP

---

- Ergonic® Pump System (EPS) with color Ergonic Graphic Display (EGD)
- Free flow hydraulic system for smooth, controllable pumping
- Multi-piece piston cup design
- Hard-chromed material cylinders
- Redundant proximity sensor system with function indicators
- Fully adjustable volume control for very slow pumping with full concrete pressure and boom speed
- Modular pump control box

## EZ CLEAN OUT RS 909 HOPPER

---

- Large 19.4 ft<sup>3</sup> (550L) capacity
- Grate-mounted vibrator
- Multi-piece grate featuring bolted connections
- Hopper grate RFID safety switch
- Hinged splash guard covers hopper during transit
- Lower hopper height allows easy discharge from ready mix truck
- Automatic lubrication
- Hopper work light

## S-VALVE

---

- Ideal for high pressure applications and harsh mixes
- Hard-faced S-Valve
- Gradual 9" to 7" (230 to 180mm) reduction
- Thick-walled valve construction
- Lasting wear over years of use

## CLEAN OUT

---

- Fast and easy clean out
- 406 psi (28 bar) hydraulically-driven water pump
- Wash out kit and hose
- Integrated 185 gallon (700L) water tank in pedestal



The PRO-VANTAGE® Warranty Plan extends the coverage on all Putzmeister BSF boom pumps for a total of 36 months or 6,600 hours at no extra charge. Domestic only.



**BETTER BOOM DESIGN**

Putzmeister's "smart design" boom incorporates welding seams below the edge of maximum stress. The new 56Z rectangle boom design minimizes boom bounce, and is easier for the hoseman to maneuver. The boom features more straight pipe for a less stressful concrete flow and longer wear on parts. The Z-Fold configuration handles space-restrictive areas and can pump even when the boom is not fully extended.

Putzmeister's boom design is highly responsive and has been optimized for the greatest maneuverability and flexibility available, resulting in a larger operational range.



**CONVENIENCE AND CONTROL**

The Automatic Frequency Management (AFM) system on the standard HBC proportional radio remote ensures minimal interference with other frequency transmitters. A fully proportional cable remote is also standard. Unlike other remote control systems, the radio and cable remote systems are independent, offering redundancies to ensure proportional operation with either the radio or cable remote.



**RS 909 HOPPER**

Putzmeister's robust, yet lightweight EZ Clean Out RS 909 hopper is engineered for performance and durability. Offering 19.4 ft<sup>3</sup> (550L) capacity, the hopper uses one remixer paddle motor and grate-mounted vibrator. The multi-piece grate features bolted connections that allow for easy maintenance. An innovative RFID safety switch incorporated in the hopper disables the machine when the grate is opened.

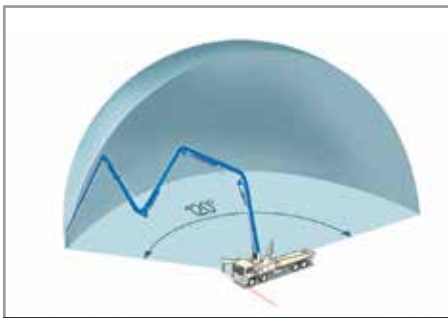

**ONE-SIDED SUPPORT (OSS) SYSTEM**

For enhanced job site versatility, Putzmeister's unique OSS system allows the operator to reduce the outrigger extension on one side of the unit to create a smaller overall machine footprint. Utilizing a series of sensors, OSS enables the unit to maintain a defined and safe 120 degree working envelope on space restrictive sites that demand a larger boom.



**ERGONIC® PUMP CONTROL SYSTEM (EPS)**

The computer-aided EPS constantly monitors and regulates the operation of the concrete pump and truck engine. The electronic regulation of this system means the pump always runs at peak performance. EPS results in more productivity and greater efficiency with less for the operator to worry about. The color Ergonic Graphic Display (EGD) provides EPS monitoring from one convenient location.



**FUEL ECONOMY**

Switch gears and save with Putzmeister's patented Econo-Gear.™ The exclusive design allows the Mack chassis engine to run at a lower rpm, achieving less stress on wear parts, lower noise levels and reduced fuel consumption. Econo-Gear makes a significant impact on job site safety and profitability with an estimated 10-15% savings.

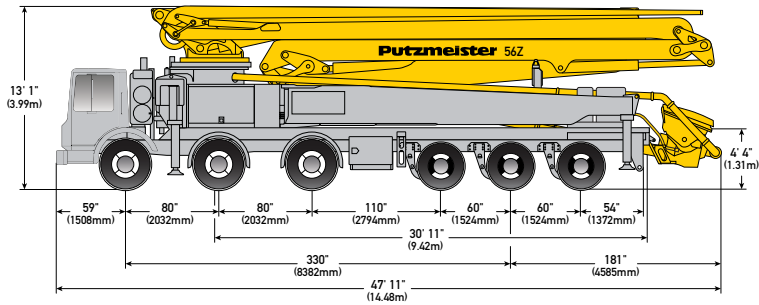

### 56Z-METER TRUCK-MOUNTED SPECIFICATIONS

Length	47' 11"	(14.48m)
Width	8' 2"	(2.50m)
Height	13' 1"	(3.99m)
Wheelbase	330"	(8,382mm)
Front axle weight	52,773 lbs	(23,938kg)
Rear axle weight	48,747 lbs	(22,111kg)
Approx total weight	100,080 lbs	(45,396kg)

Based on Model MACK MRU 613 with .16H pump cell.  
Weights are approximate and include pump, boom, truck, driver and full fuel. Varies with options selected.  
Dimensions will vary with different truck makes, models and specifications.

### BOOM SPECIFICATIONS | Z-FOLD DESIGN

<b>Height &amp; Reach</b>		
Vertical reach	180' 10"	(55.12m)
Horizontal reach	163' 10"	(49.94m)
Reach from front of truck*	152' 6"	(46.48m)
Reach depth	132' 3"	(40.30m)
Unfolding height	51' 3"	(15.62m)

<b>5-Section Boom</b>		
1st section articulation	90°	
2nd section articulation	180°	
3rd section articulation	180°	
4th section articulation	245°	
5th section articulation	210°	

1st section length	34' 1"	(10.40m)
2nd section length	26' 8"	(8.12m)
3rd section length	30' 6"	(9.30m)
4th section length	37' 8"	(11.48m)
5th section length	38' 9"	(11.80m)

<b>General Specs</b>		
Pipeline Size (ID) metric ends	5"	(125mm)
Rotation	365°	
End hose — length	10' 0"	(3.00m)
End hose — diameter	5"	(125mm)
Outrigger spread L - R — front	30' 6"	(9.30m)
hydraulically extend out & down		
Outrigger spread L - R — rear	40' 2"	(12.30m)
hydraulically swing out & extend down		

### PUMP SPECIFICATIONS

	56Z.16H	56Z.16H LS
Output — rod side	210 yd <sup>3</sup> /hr (160m <sup>3</sup> /hr)	—
Output — piston side	146 yd <sup>3</sup> /hr (112m <sup>3</sup> /hr)	210 yd <sup>3</sup> /hr (160m <sup>3</sup> /hr)
Pressure — rod side	1,233 psi (85 bar)	—
Pressure — piston side	1,885 psi (130 bar)*	1,233 psi (85 bar)
Material cylinder diameter	9" (230mm)	10" (250mm)
Stroke length	83" (2,100mm)	83" (2,100mm)
Maximum strokes per minute — rod side	31	—
Maximum strokes per minute — piston side	21	26
Volume control	0-Full	0-Full
Vibrator	Standard	Standard
Hard-chromed material cylinders	Standard	Standard
Hydraulic system	Free Flow	Free Flow
Hydraulic system pressure	5,075 psi (350 bar)	5,075 psi (350 bar)
Differential cylinder diameter	5.5" (140mm)	5.5" (140mm)
Rod diameter	3.1" (80mm)	3.1" (80mm)
Maximum size aggregate	2.5" (63mm)	2.5" (63mm)
Water tank — pedestal	185 gal (700L)	185 gal (700L)

Maximum theoretical values listed.  
\* Applies to units mounted on PMA stock truck — MACK MRU 613  
• Standard delivery line system rated at max line pressure of 1,233 psi (85 bar)

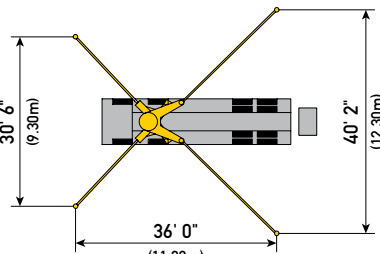
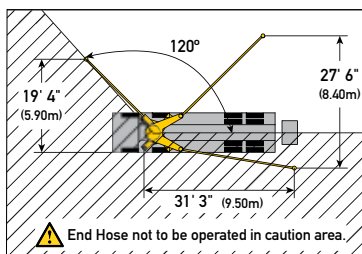
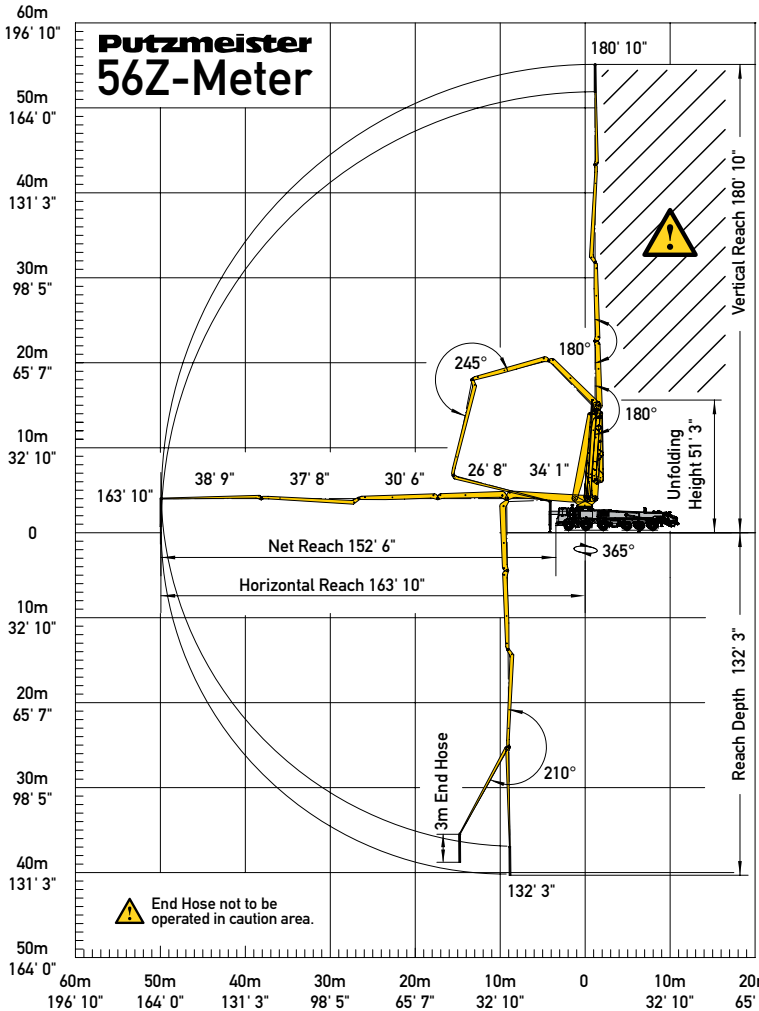

With one-sided support (OSS) 120°

Photos and drawings are for illustrative purposes only.

Authorized Distributor

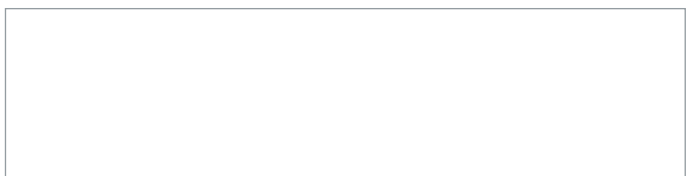

**Putzmeister**

Putzmeister America, Inc. Phone (262) 886-3200  
1733 90th Street Toll-free (800) 884-7210  
Sturtevant, WI 53177 USA Fax (262) 884-6338

PutzmeisterAmerica.com

pmr@putzam.com